

A-A 1 : 5

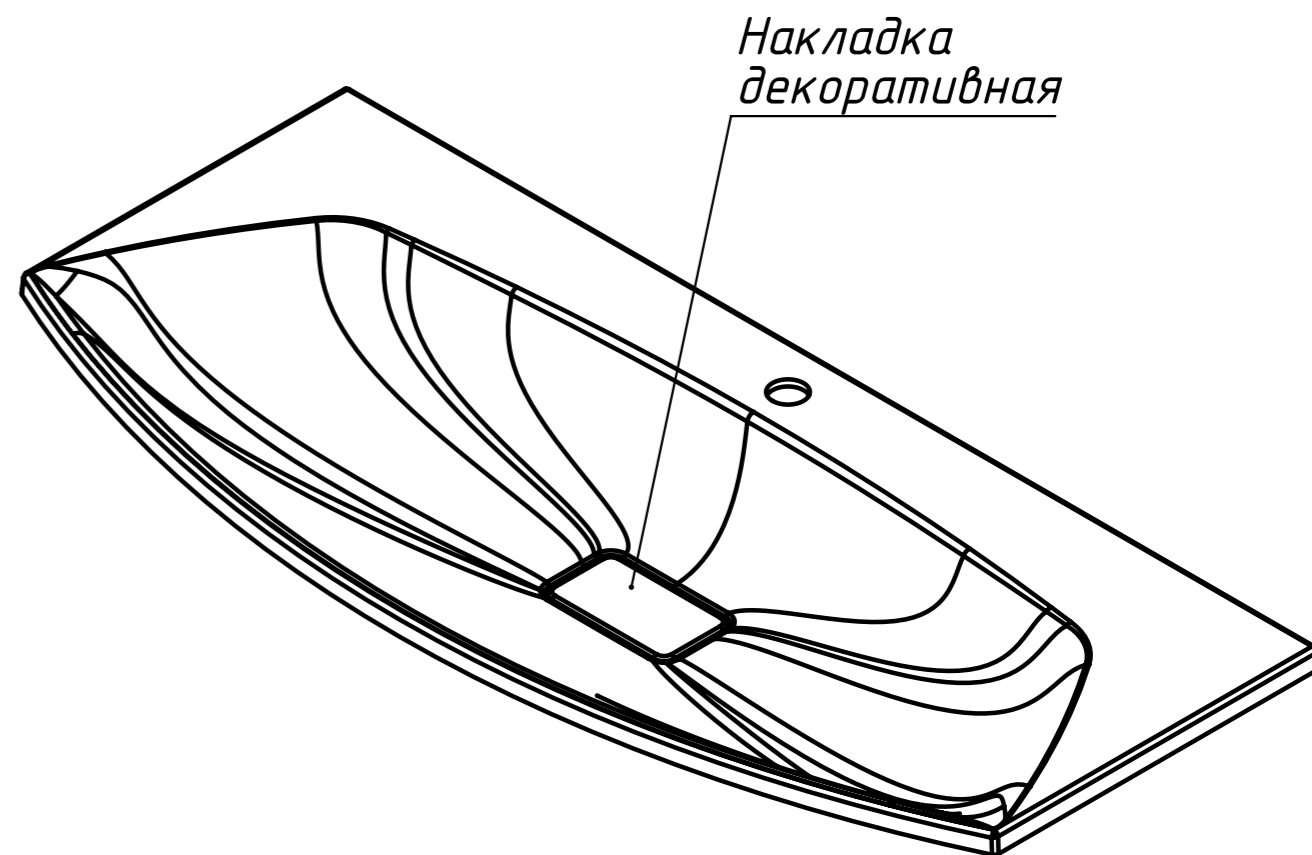
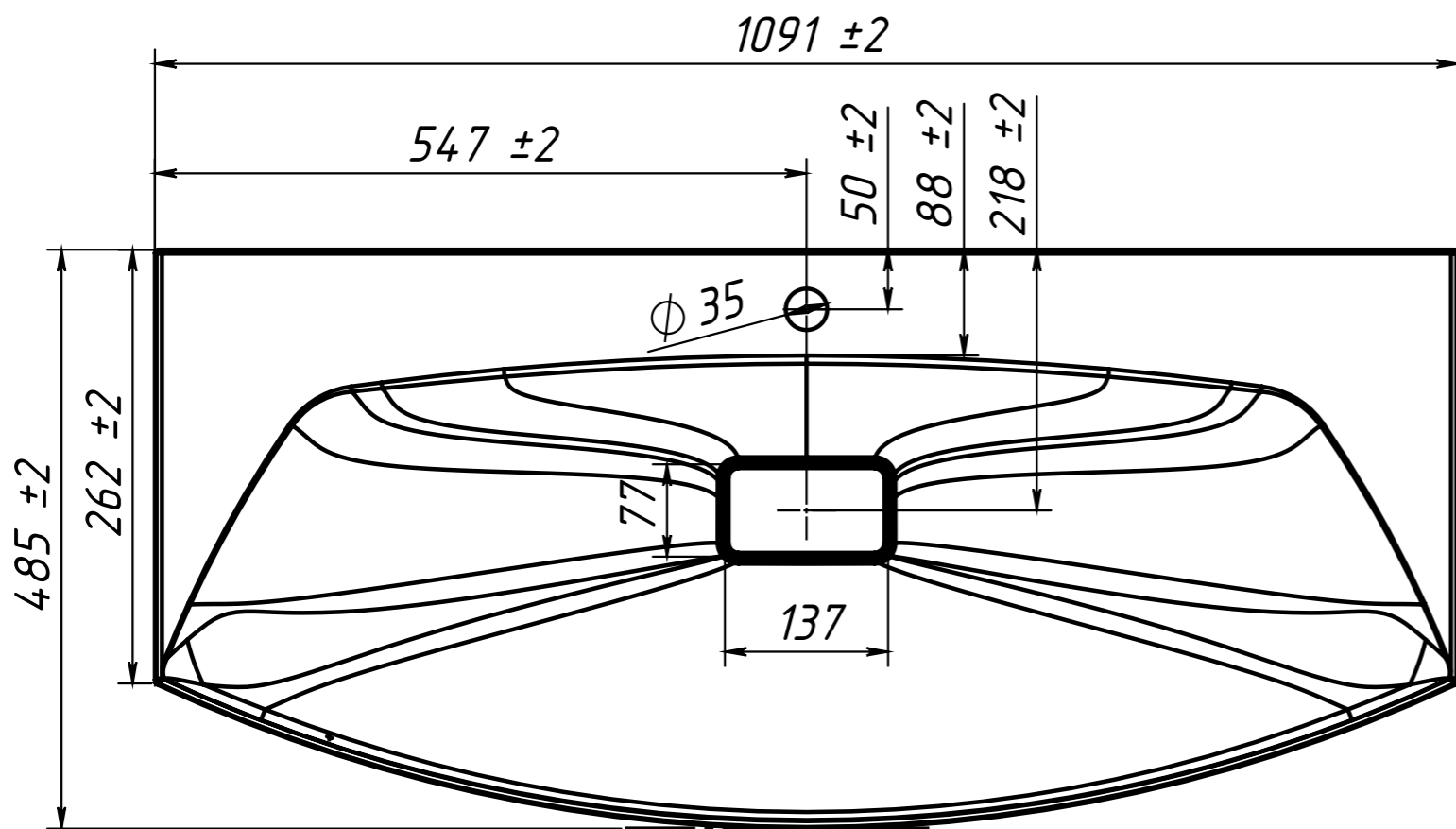
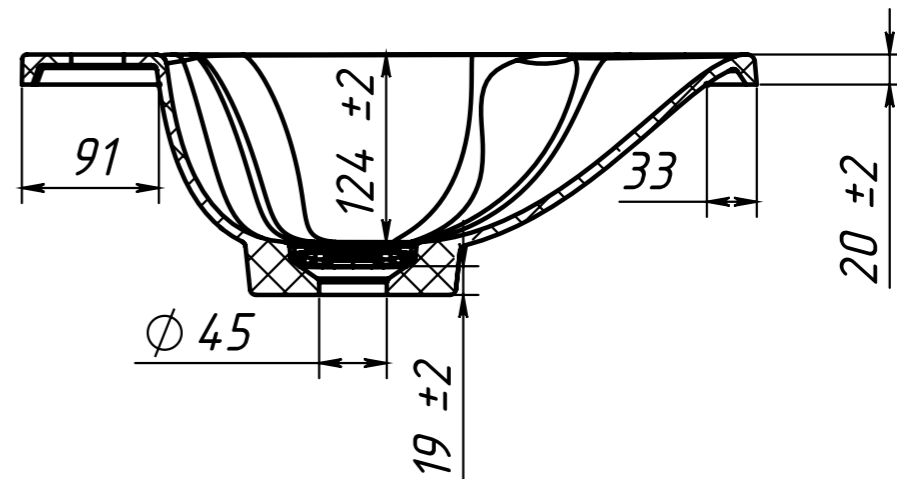

Инв. N подл.	Подп. и дата
Взаим. инв. N дубл.	Подп. и дата

Изм/Лист	N докум	Подп.	Дата
----------	---------	-------	------